

S/S by AR 633-15, 7 Apr 59

# PROCEDURE FOR MILITARY EXECUTIONS



Pentagon Library (ANR-PL)  
ATTN: Military Documents Section  
Room 1A415, Pentagon  
Washington, DC 20310-6050

DEPARTMENT OF THE ARMY

DECEMBER 1947

---

**RESTRICTED. DISSEMINATION OF RESTRICTED MATTER.**—No person is entitled solely by virtue of his grade or position to knowledge or possession of classified matter. Such matter is entrusted only to those individuals whose official duties require such knowledge or possession. (See also AR 380-5.)

---

THE ARMY LIBRARY  
WASHINGTON, D. C.

DEPARTMENT OF THE ARMY

Washington 25, D. C., 9 December 1947

Department of the Army Pamphlet 27-4, Procedure for Military Executions, is published for the information and guidance of all concerned.

[AG 250 (17 Sep 47)]

BY ORDER OF THE SECRETARY OF THE ARMY:

OFFICIAL:

EDWARD F. WITSELL  
*Major General*  
*The Adjutant General*

DWIGHT D. EISENHOWER  
*Chief of Staff,*  
*United States Army*

DISTRIBUTION:

USAF (10); AGF (10); T (10); Base Comd (10); Def Comd (10); Arm & Sv Bd (2), except 19 (20); Adm Sv (2); Tech Sv (2); FC (1); Gen & Sp Sv Sch (2), except 19 (100); A (10); CHQ (10); D (2); AF (2).

For explanation of distribution formula, see TM 38-405.



**PROCEDURE FOR MILITARY EXECUTIONS**

CHANGES  
No. 1

DEPARTMENT OF THE ARMY  
WASHINGTON 25, D. C., 24 June 1953

DA Pamphlet No. 27-4, 9 December 1947, is changed as follows:

**1. Authority**

(Superseded)

In adjudging the sentence of death a court-martial will not prescribe the method of execution. In accordance with paragraph 126a, Manual for Courts-Martial, United States, 1951, a sentence to death which has been finally ordered executed will be carried into effect by shooting or hanging. (See pertinent Department of the Army letters and regulations.)

**2. Time and Place**

a. (Superseded) The authority ordering the execution of a sentence of death issues instructions concerning the time and place of execution, any designations or instructions in this particular matter by the court or the convening authority being disregarded.

b. (Rescinded.)

**4. Insanity**

If, after issuance of order of execution, the prisoner shows signs of having become insane, the officer designated to execute the sentence may cause a board to be convened under the provisions of SR. 600-440-1 to determine the sanity of the prisoner. If the board \* \* \* of further instructions.

**15. Execution.**

\* \* \* \* \*

2. The officer charged with the execution will direct the burial party in the disposal of the body as prescribed by AR 210-190 and AR 30-1820.

**17. Executioner**

An official experienced executioner will be appointed. If one is not available to the command, a professional civilian executioner may be obtained and appointed; payment at the local rate, but not to exceed one hundred dollars (\$100.00) per execution, may be authorized and paid from Contingencies of the Army, Project 416, Maintenance

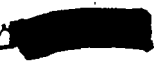

DA PAMPHLET 27-4

C 1

2

and Operations, Project 1554. In the event \* \* \* and appointed executioner.

**20. Disposition of Remains**

If the next \* \* \* by pertinent regulations. (See AR 210-190 and AR 30-1820.)

**21. Disposition of Effects**

See Section 6, The Act of 5 May 1950 (PL 506, 81st Congress) and SR 600-560-5. War criminals and \* \* \* disposition of effects.

**22. Notification and Reports**

The officer designated \* \* \* circumstances attendant thereon. He will likewise, in addition, comply with the requirements of section VI, SR 600-400-10. The quartermaster or \* \* \* in AR 30-1815.

[AG 250 (19 May 53)]

BY ORDER OF THE SECRETARY OF THE ARMY:

OFFICIAL:

WM. E. BERGIN  
Major General, USA  
The Adjutant General

J. LAWTON COLLINS  
Chief of Staff, United States Army

DISTRIBUTION:

*Active Army:*

GSUSA (2); SSUSA (2); Tech Svc (2); Admin & Tech Svc Bd (2), 19 (10); AFF (5); OS Maj Comd (10); Base Comd (10); MDW (2); A (10); CHQ (10); Div (2); FT (1); Sch (2) except 19 (100).

*NG:* None.

*Army Reserve:* None.

For explanation of distribution formula, see SR 310-90-1.

Pentagon Library (ANR-PL)  
Military Documents Section  
Room 1A518, Pentagon  
Washington, DC 20310-6050

TAGO 4601B

## SECTION I. GENERAL

Authority .....	1	1
Time and Place .....	2	1
Delegation of Authority .....	3	1
Insanity .....	4	1
Pregnancy .....	5	2
Witnesses .....	6	2
Multiple Executions .....	7	2
Escort .....	8	3
Chaplain .....	9	3
Medical Officer .....	10	3
Interpreter .....	11	3
Miscellaneous .....	12	3

## II. EXECUTION BY MUSKETRY

Officer Charged with Execution .....	13	5
Assembly of Escort .....	14	6
Execution .....	15	6

## III. EXECUTION BY HANGING

Officer Charged with Execution .....	16	9
Executioner .....	17	10
Assembly .....	18	10
Execution .....	19	10

## IV. PROCEEDINGS AFTER EXECUTION

Disposition of Remains .....	20	12
Disposition of Effects .....	21	12
Notification and Reports .....	22	12

## V. DEPARTURES

Limited Facilities .....	23	13
In Time of War .....	24	13

## VI. STRUCTURES

Permanent Scaffold .....	25	14
Semipermanent Scaffold .....	26	14
Emergency Structures .....	27	14

## VII. EQUIPMENT

Hood .....	28	15
Collapse Board and Binding Strap .....	29	15
Rope .....	30	15
Post .....	31	15

*This pamphlet supersedes WD Pamphlet 27-4, 12 June 1944, including C 1,  
12 August 1944*

## SECTION I GENERAL

### 1. Authority

Military executions will be by musketry or by hanging as designated by a court martial in imposing the sentence of death. (Manual for Courts-Martial, 103a, page 93.)

### 2. Time and Place

a. The authority ordering the execution of a sentence of death designates or causes to be designated the time and place for such execution, any designation made by the court as to such matters being disregarded. (Manual for Courts-Martial, 87b, page 76.)

b. Where it is found to be impracticable to proceed with the execution at the time named or at the place selected, the officer designated by the confirming authority to execute the sentence will designate at the earliest opportunity another time or place, and the execution will proceed according to the new designation.

### 3. Delegation of Authority

a. The officer designated by the confirming authority to execute the approved sentence of death will be responsible for its execution. He may delegate to a subordinate officer the duties connected with the carrying out of the execution.

b. The subordinate officer named will be one under the direct control of the delegating authority. He will be duly and officially named by an order of the officer designated to execute the sentence and directed therein to carry out the execution.

### 4. Insanity

If, after issuance of order of execution, the prisoner shows signs of having become insane, the officer designated to execute the sentence may cause a board to be convened under the provisions of AR 600-500 to determine the sanity of the prisoner. If the board finds the prisoner to be sane, the execution will proceed as ordered; but in the event he shall be found to be insane, notice of the findings of the board, including, if practicable, its report, will be transmitted to the confirming authority if other than the Presi-

dent, or to The Adjutant General if the sentence was confirmed by the President, and the execution will be stayed pending the receipt of further instructions.

## **5. Pregnancy**

If the prisoner is a woman and medical examination reveals that she is pregnant, immediate report of the fact will be made to the confirming authority or to The Adjutant General, as prescribed in paragraph 4, and the execution will be stayed pending the receipt of further instructions.

## **6. Witnesses**

The officer designated to execute the sentence will prescribe whether the execution will be public or private, rules of secrecy as to time, place, and the presence of witnesses, military or civilian, including members of the press if the presence of the latter is deemed proper. In the case of the execution of a foreign national, the officer designated to execute the sentence will prescribe whether persons of the same nationality as the condemned may be present. If troops are designated to observe an execution by musketry, these troops will be paraded and formed into the three sides of a hollow rectangle, facing inward and toward the site on which the prisoner is to be placed. In executions by hanging, the troops, if designated to witness the execution, will be paraded and formed in a square around the gallows. No photographs nor motion pictures of the actual execution will be permitted except for official purposes. The environs of the place of execution will be closely and securely guarded to prevent the intrusion of unauthorized persons. All persons in attendance will be cautioned that no demonstrations or unseemly conduct will be tolerated. Troops will assume the position of attention upon the approach of the escort and will remain at attention until the conclusion of the ceremony.

## **7. Multiple Executions**

In multiple executions, the prisoners may be executed either simultaneously or in succession. Where two or more prisoners are to be executed in succession, the same execution party or gallows may be used for each execution. Where two or more prisoners are to be executed simultaneously by musketry, a separate execution party will be provided for each of the prisoners. The latter will be placed in line at an interval of ten paces. Where two or more prisoners are to be executed simultaneously by hanging, the officer

designated to execute the sentence will prescribe the number of gallows to be erected, and the prisoners will be hanged from the gallows simultaneously or by groups.

## **8. Escort**

The escort for execution may be mounted, dismounted, or motorized, but upon arrival at the scene of execution, mounted or motorized escorts will form in the manner prescribed for dismounted escorts. The minimum escort will consist of components as prescribed in paragraph 14*b*.

## **9. Chaplain**

In all executions, a chaplain of the prisoner's choice will be provided if practicable. If no chaplain of the prisoner's choice or of his particular faith and/or race is available, the officer charged with the execution of the sentence will take all reasonable measures to provide a civilian clergyman of that faith and/or race. The chaplain should be available at all times after the prisoner is notified of the time of execution.

## **10. Medical Officer**

A medical officer will be officially designated to be in attendance upon the execution. It will be his duty to determine the extinction of life in the prisoner and to make pronouncement thereof. He will furnish a death certificate to accompany the report of execution.

## **11. Interpreter**

In the event that the prisoner does not speak English, an interpreter will be officially designated to be in attendance at the notification of the prisoner (par. 12*a*) and the execution. It is his duty to interpret the charge, finding, sentence orders and any last statement made by the prisoner. Before entering upon his duties, the interpreter will take the oath of affirmation required of an interpreter for a court-martial.

## **12. Miscellaneous**

*a.* The prisoner will be notified of the time of execution no less than 24 hours prior thereto if practicable at which time the order directing the execution will be read to him by the officer charged with the execution of the sentence or by some officer at his direction. The chaplain should be present.

b. If practicable due notice will be given to the next of kin of the prisoner and an opportunity provided for the claiming of the body following the execution.

c. A prisoner in the Armed Forces of the United States will be dressed in regulation uniform from which all decorations, insignia, or other evidences of membership therein have been removed. Likewise, no such evidences will appear on any clothing used in burial. Similar procedures may be dispensed with, in the discretion of the officer responsible for carrying out the execution (or higher authority) in the case of a prisoner in the armed forces of another nation. A prisoner not within the foregoing categories may be dressed in any clothing available.

d. After the prisoner is notified of the time of execution (*a* above) the commanding officer of the place of confinement will, where practicable, approve any reasonable special request of the prisoner, including special request for food, and permission to have in his possession a Bible, Rosary, or similar religious articles during the execution. Sufficient writing paper and envelopes should be furnished and no limit placed on the number of letters which may be written. All letters are subject to censorship and may or may not be forwarded.

## SECTION II EXECUTION BY MUSKETRY

### 13. Officer Charged with Execution

The officer charged with the execution will command the escort and make the necessary arrangements for the conduct of the execution. He will—

*a.* Instruct and rehearse the escort and the execution party in their duties, insuring that all members of the execution party are qualified in the weapon to be used.

*b.* Arrange for the receipt of the prisoner by the prisoner guard.

*c.* Arrange for an execution party of eight men and one sergeant.

*d.* Arrange for a chaplain to accompany the prisoner.

*e.* Arrange for the presence of a medical officer at the scene of the execution.

*f.* Cause a post with proper rings placed therein for securing the prisoner in an upright position to be erected at the place of execution.

*g.* Cause eight rifles to be loaded in his presence. Not more than three nor less than one will be loaded with blank ammunition. He will place the rifles at random in the rack provided for that purpose.

*h.* Provide a black hood to cover the head of the prisoner.

*i.* Provide a 4-inch round target, white or black as appropriate; a black target will be used when light colored clothing is worn.

*j.* Cause the prisoner's arms to be secured either behind his back or in front at the waist (fig. 1), before or immediately after his receipt by the prisoner guard.

*k.* Arrange for an ambulance or other conveyance with sufficient personnel to be in attendance upon the execution to receive and care for the body. In the event a contract undertaker is used by the quartermaster, his services may be substituted. See AR 30-1820.

*l.* Provide straps to secure the prisoner to the post at waist and ankles. (See par. 29*b.*)

a. If a band is prescribed, it will be formed in accordance with chapter 3, FM 12-50, proceed to the exterior door of the place of imprisonment at which the prisoner is to be received by the prisoner guard, and halt near the door, facing in the direction of the scene of the execution.

b. The prisoner guard will consist of twelve men armed with rifles, under the command of a sergeant armed with a pistol. The prisoner guard will form in double ranks and at the proper time will proceed to the place of imprisonment to receive the prisoner.

c. The main guard will consist of one or more platoons and will form in the rear of the band.

d. The execution party will be formed unarmed and proceed to a previously prepared rack of rifles, secure arms, and move to the scene of the execution, halting 15 paces from and facing the position to be taken by the prisoner. At close interval, and at order arms, the party will await the arrival of the prisoner and escort.

e. At the designated time the prisoner, with his arms bound securely behind his back or in front at the waist (fig. 1), accompanied by the chaplain, will be received by the prisoner guard and placed between the ranks. The escort will then proceed toward the scene of the execution, the band playing the "Dead March."

f. The escort will approach the scene of the execution on line with the open side of the rectangle formed by the witnessing troops. The band will move past the point at which the prisoner is to be placed, and will take position on the opposite side of the rectangle, facing the scene of the execution. The prisoner guard, prisoner, and chaplain will proceed directly to the prisoner's post, halt, and face the execution party. The main guard will proceed to a point 5 paces behind the execution party and form a line facing the scene of execution.

## 15. Execution

a. The officer charged with the execution will take position in front of the execution party and face the prisoner. If troops are present, he will read the charge, finding, sentence, and orders aloud to the prisoner. He will then notify the prisoner and the chaplain that a brief time will be allowed the prisoner for any last statement. After a reasonable time, he will order the sergeant of the execution party to secure the prisoner to the post and to place the hood over his head. Then the medical officer will place the target over the prisoner's heart. The prisoner prepared, the officer

charged with the execution will order the prisoner guard to join the main guard; the chaplain and medical officer will retire to the flank taken by the band. The officer charged with the execution will take position 5 paces to the right of and 5 paces to the front of the execution party.

b. Commands for the execution will, when practical, be given by a combination of manual and oral signals as prescribed.

(1) When the officer charged with the execution raises the right arm vertically overhead, palm forward, fingers extended and joined, the execution party will come to the "Ready" position as prescribed for firing a volley, and will unlock rifles.

(2) When the officer charged with the execution lowers his arm to a horizontal position in front of his body, the execution party will take the position of "Aim."

(3) When the officer charged with the execution drops his arm directly to his side and orally commands: FIRE, the execution party will fire simultaneously.

(4) The officer charged with the execution will then bring the execution party to "Order Arms."

c. When the use of manual signals is not practical, the following oral commands are prescribed:

(1) At the command READY, the execution party will take that position and unlock rifles.

(2) At the command AIM, the execution party will take that position with rifles aimed at target on the prisoner's body.

(3) At the command FIRE, the execution party will fire simultaneously.

d. The officer charged with the execution will join the medical officer who will examine the prisoner and, if necessary, direct that the "coup de grace" be administered. Should the medical officer so decide, the sergeant of the execution party will administer the "coup de grace," with a hand weapon, holding the muzzle just above the ear and one foot from the skull.

e. Under exceptional circumstances, the officer charged with the execution, with the permission of the commanding officer, may detail an extra file of six men to administer the "coup de grace." This file will form the rear rank of the execution party, and if it is necessary to administer the "coup de grace," will move in front of the execution party and fire, at the command of the officer charged with the execution.

f. Upon pronouncement of the death of the prisoner by the medical officer, the execution party will proceed to the racks from which the rifles were originally obtained, and replace the rifles in the racks at random. The execution party will then be dismissed.

g. The escort, with the band playing a lively air, will return to their parade ground and be dismissed.

h. The witnessing troops will parade in column in front of the body and proceed to their respective parade grounds where they will be dismissed.

i. The officer charged with the execution will direct the burial party in the disposal of the body as prescribed by AR 210-500 and AR 30-1820.

## SECTION III

### EXECUTION BY HANGING

#### 16. Officer Charged with Execution

The officer charged with the execution will command the escort and make the necessary arrangements for the conduct of the execution. He will—

- a. Instruct components of the escort in their duties.
- b. Arrange for the receipt of the prisoner by the prisoner guard.
- c. Arrange for a chaplain to accompany the prisoner.
- d. Arrange for the presence of a medical officer at the scene of the execution.
- e. Provide a proper gallows.
- f. Provide a black hood to cover the head of the prisoner.
- g. Provide a collapse board for use if necessary.
- h. Cause the prisoner's arms to be secured before or immediately upon his receipt by the prisoner guard. The arms may be secured either behind the back or in front, fastened to the belt (fig. 1).
- i. Arrange for a burial party as prescribed in paragraph 13k.
- j. Determine the proper amount of drop of the prisoner through the trap door. A standard drop chart for normal men of given weights is given below. Variation of the drop because of physical condition may be necessary. A medical officer should be consulted to determine whether any factors, such as age, health, or muscular condition will affect the amount of drop necessary for a proper execution.

120 lbs or less	8' 1"	170 lbs	6' 0"
125 lbs	7' 10"	175 lbs	5' 11"
130 lbs	7' 7"	180 lbs	5' 9"
135 lbs	7' 4"	185 lbs	5' 7"
140 lbs	7' 1"	190 lbs	5' 6"
145 lbs	6' 9"	195 lbs	5' 5"
150 lbs	6' 7"	200 lbs	5' 4"
155 lbs	6' 6"	205 lbs	5' 2"
160 lbs	6' 4"	210 lbs	5' 1"
165 lbs	6' 2"	220 lbs and over	5' 0"

- k. Rehearse the execution within 24 hours prior to the scheduled time for the execution. A sandbag or similar object approximat-

## 17. Executioner

An official experienced executioner will be appointed. If one is not available to the command, a professional civilian executioner may be obtained and appointed; payment at the local rate, but not to exceed one hundred dollars (\$100.00) per execution, may be authorized and paid from Contingencies of the Army, Project 416. In the event a professional executioner is not available, a suitable emotionally stable member of the command will be selected and appointed executioner.

## 18. Assembly

a. If a band is prescribed, it will be formed in accordance with chapter 3, FM 12-50, proceed to the exterior door of the place of imprisonment at which the prisoner is to be received by the prisoner guard, and halt near the place of imprisonment, facing in the direction of the scene of the execution.

b. The prisoner guard will consist of twelve men armed with rifles, under the command of a sergeant armed with a pistol. The prisoner guard will form in double ranks and at the proper time will proceed to the door to receive the prisoner.

c. The main guard will consist of one or more platoons and will form in the rear of the band.

d. At the designated time the prisoner, with his arms bound securely behind his back, accompanied by the chaplain, will be received by the prisoner guard and placed between the ranks. The escort will then proceed toward the scene of the execution, the band playing the "Dead March."

e. Upon the arrival of the escort, consisting of the band, prisoner guard, main guard, prisoner and chaplain within the square formed by the witnessing troops before the gallows, the sergeant of the prisoner guard and a sergeant from the main guard will conduct the prisoner to the platform of the gallows, the officer charged with the execution and the chaplain preceding the prisoner.

## 19. Execution

a. If troops are present, the officer charged with the execution will face the prisoner and read aloud to him the charge, finding, sentence and orders. He will then notify the chaplain and the

prisoner that a brief time will be allowed the prisoner for any last statement. After a reasonable time he will have the executioner place the hood over the prisoner's head and bind his ankles. The executioner will then adjust the noose around the prisoner's neck and remain beside the prisoner. The sergeant of the prisoner guard or other individual designated by the officer charged with the execution will then place himself in position at the trigger and, upon a signal from said officer, will spring the trap. The medical officer will then examine the body for time of death and report to the officer charged with the execution.

b. Upon the pronouncement of the death of the prisoner, the escort, with the band playing a lively air, will return to the parade ground and be dismissed.

c. The witnessing troops will move to their respective areas where they will be dismissed.

d. The officer charged with the execution will direct the burial party in the disposal of the body as prescribed by the commanding officer.

## SECTION IV PROCEEDINGS AFTER EXECUTION

### 20. Disposition of Remains

If the next of kin or other relatives of the deceased desire the body, the officer designated to execute the sentence will, if practicable, permit its delivery to them for burial. If no such claim is made, he will cause it to be buried in a post or civilian cemetery or at the place of death, whichever may be deemed proper and is authorized by pertinent regulations. (See AR 210-500 and AR 30-1820.) c.1

### 21. Disposition of Effects

See Articles of War 112 and sections V, VI, and VII, AR 600-550. War criminals and civilian resident criminals convicted by a Military Tribunal and executed by military authorities are considered as subject to military law for the purpose of disposition of effects. See c.1

### 22. Notification and Reports

The officer designated to execute the sentence will notify The Adjutant General immediately following the execution, by fastest available method of communication, of the carrying out of the sentence of death, the time, place and any unusual circumstances attendant thereon. He will likewise, in addition, comply with the requirements of section II, AR 600-550. The quartermaster or other officer in charge of burial will furnish report as provided in AR 30-1815. c.1

## SECTION V DEPARTURES

### 23. Limited Facilities

If the facilities are not available for the carrying out of each of the provisions of this pamphlet or if the exigencies of the situation require it, the officer designated to execute the sentence may make the necessary departures from the provisions herein contained, except that he may not change the mode of execution. Any departure will be reported in writing to the authority ordering the execution.

### 24. In Time of War

In time of war:

*a.* Only the minimum number of troops necessary to accomplish the execution need be employed.

*b.* All instructions pertaining to the use of a band are inoperative.

## SECTION VI STRUCTURES

### 25. Permanent Scaffold

A permanent type, demountable scaffold, with a metal trigger mechanism, will be erected when the need for such a structure is determined by the commanding officer. (See fig. 2.) Where available, troops belonging to the Corps of Engineers will be employed in the constructing of the scaffold, but where not available, or where it is more practicable, other troops or civilians may be employed. Preliminary tests will be made to insure the strength of the rope in the stability of the scaffold's construction. If facilities are limited, a trap door on the second floor of the building may be constructed to effect the execution, or a similar improvising employed.

### 26. Semipermanent Scaffold

A semipermanent scaffold which requires no special metal fittings may be used in executions by hanging when deemed expedient by the commanding officer. (See fig. 3.)

### 27. Emergency Structures

When the exigencies of the field so dictate, emergency type gallows may be used. (See fig. 4.)

## SECTION VII EQUIPMENT

### 28. Hood

The hood will be black, the outer surface of rough materials, split at the open end so that it will come well down on the prisoner's chest and back.

### 29. Collapse Board and Binding Strap

a. A collapse board will be provided for use in case of the collapse of the prisoner. (See fig. 5.)

### 30. Rope

The rope will be of manila hemp, at least  $\frac{3}{4}$  inch and not more than  $1\frac{1}{4}$  inches in diameter and approximately 30 feet in length. The rope will be boiled and then stretched while drying to eliminate any spring, stiffness, or tendency to coil. The hangman's knot (figure 7) will be used in the preparation of the noose. That portion of the noose which slides through the knot will be treated with wax, soap, or grease to insure a smooth sliding action through the knot. The noose will be placed snugly around the prisoner's neck in such a manner that the hangman's knot is directly behind his left ear.

### 31. Post

Design for post used in execution by musketry as mentioned in paragraph 15a, is shown in figure 6.

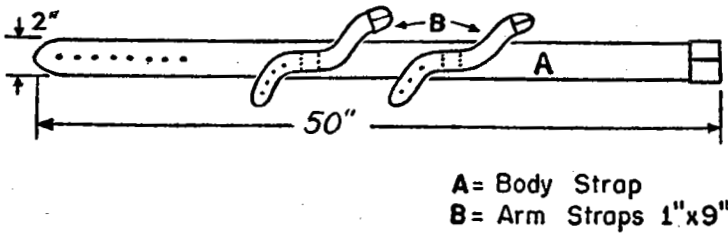
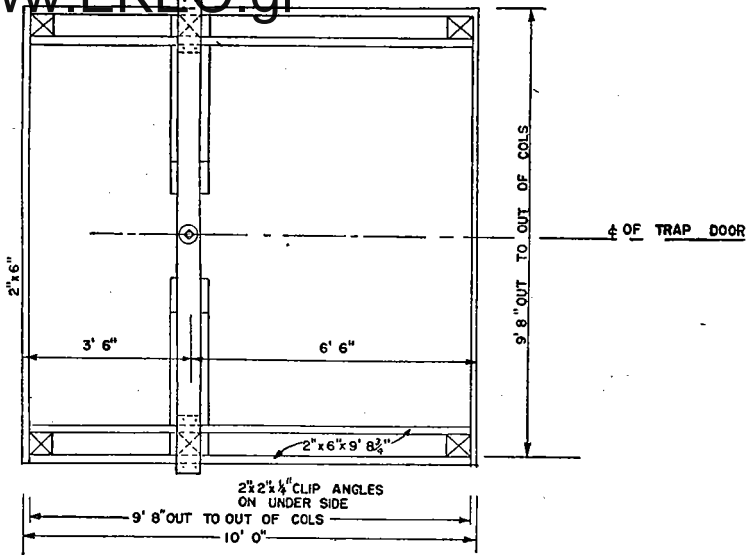
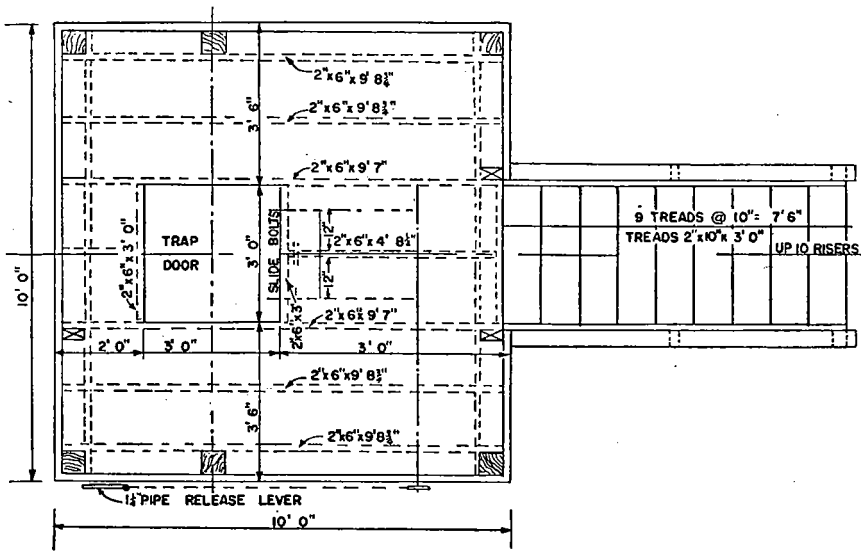

Figure 1. Binding strap.



PLAN OVER BEAM



PLATFORM AND STAIR PLAN AT SECTION A-A SCALE 1/2" = 1'

Figure 2 (1). Permanent scaffold.





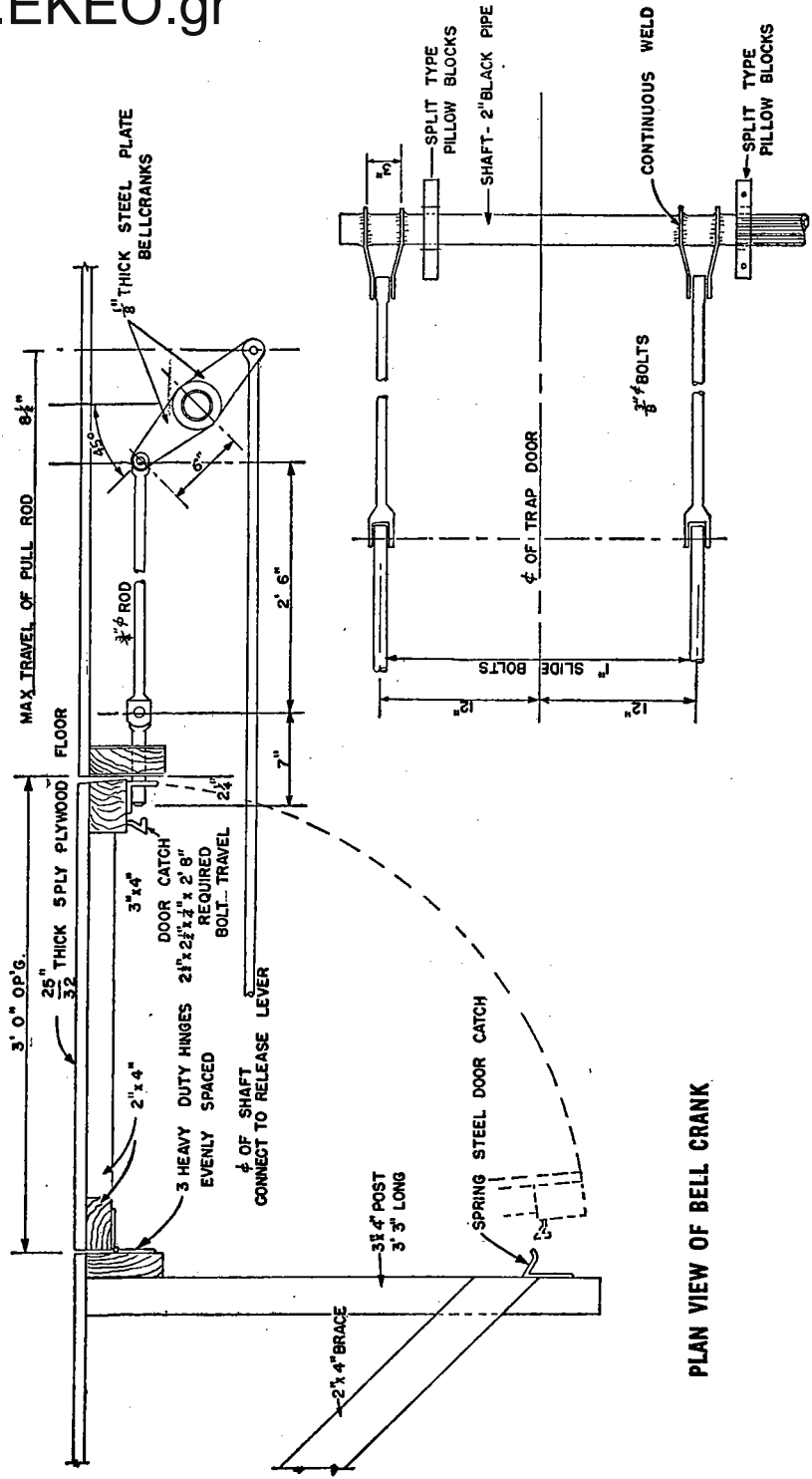

Figure 2 (4). Permanent scaffold, bell crank.

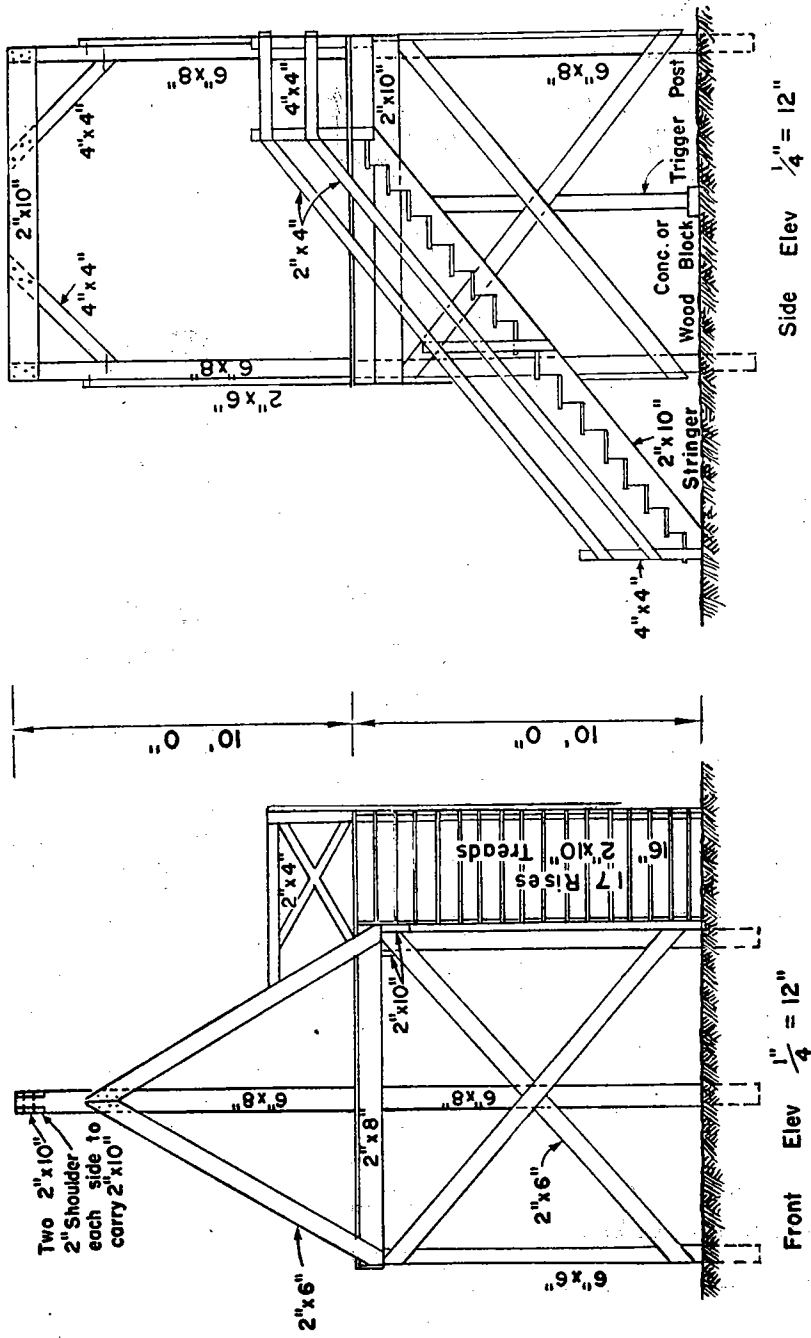
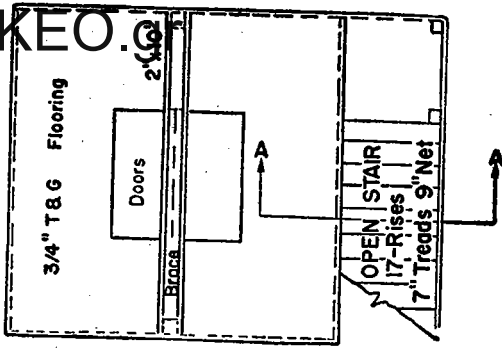
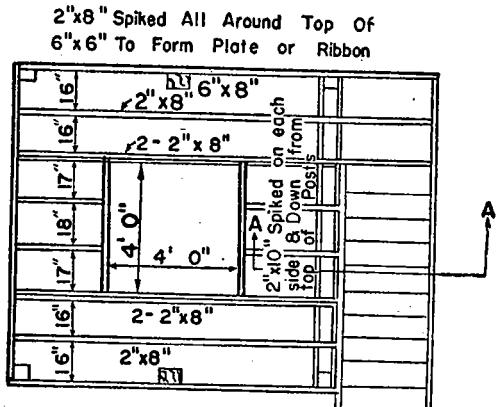

Figure 3 ①. Semipermanent scaffold.



Plan of Platform  $\frac{1}{4}'' = 12''$



Framing For Floor  $\frac{1}{4}'' = 12''$

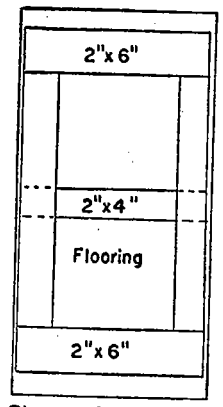
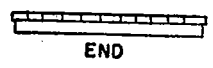

Plan of Underside Trap Door, One Half  $\frac{3}{4}'' = 12''$

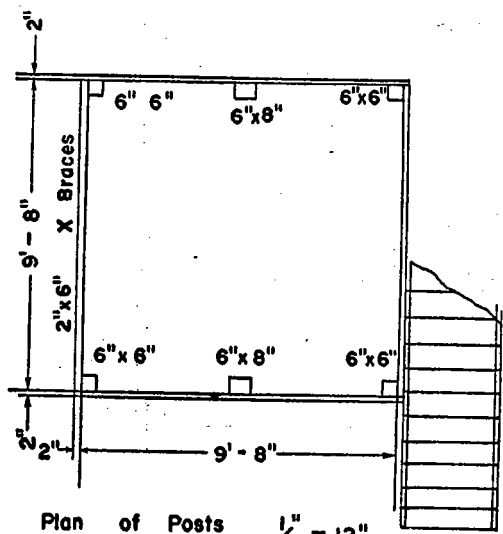

Plan of Posts  $\frac{1}{4}'' = 12''$

Figure 3 (2). Semipermanent scaffold, details.

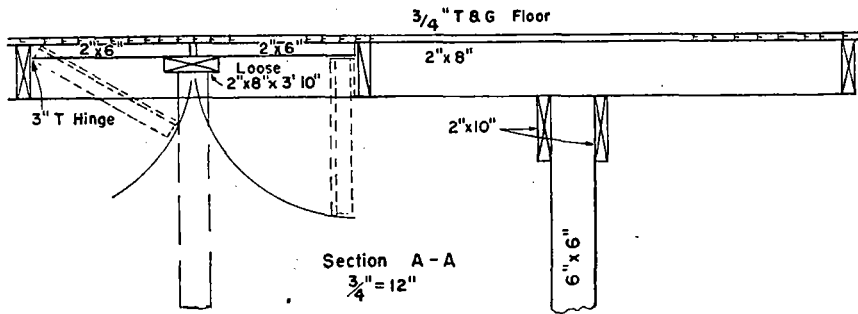

Elevation of Trigger Post  $\frac{3}{4}'' = 12''$

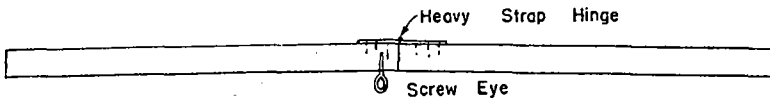

4" x 4" 9' 6" Long Cut In Two Pieces At Center  
Hinged To Stand with 1-Inch Bow At Center

### MATERIALS

2 pcs	6" x 8" - 22'	Long	Gallows Posts
4	6" x 6" - 12'		Platform Posts
2	2" x 10" - 16'		Step Stringers
4	2" x 10" - 10'		Cross Bar - Beam
3	2" x 8" - 14'		Joist-Extend for stair landing
1	2" x 8" - 12'		Joist- Short
7	2" x 8" - 10'		Joists- Regular
8	2" x 6" - 14'		X Braces
4	2" x 6" - 10'		Gallows Braces
1	4" x 4" - 10'		Knee Braces (cut to 5' 0")
4	4" x 4" - 4'		Newels
2	2" x 4" - 16'		Stair Rail
1	2" x 4" - 14'		Stair Rail
3	2" x 4" - 10'		Stair Rail & Trap Door Rail
			(Flooring if 2" thick)
			{ 10 pc 2" x 8" 12' Long
			{ 6 2" x 8" 10' Long
			{ 3 2" x 8" 8' Long
1 pc	2" x 6" - 8' Long		Trap Door Rails
1	2" x 6 3/4" 8'		140 BM 3/4" T & G Pine Flooring
4	2" x 10" - 14'		Cut into 3' 6" lengths Step Tread
1	4" x 4" - 10'		Trigger

Figure 3 ⑧. Semipermanent scaffold, details (Continued).

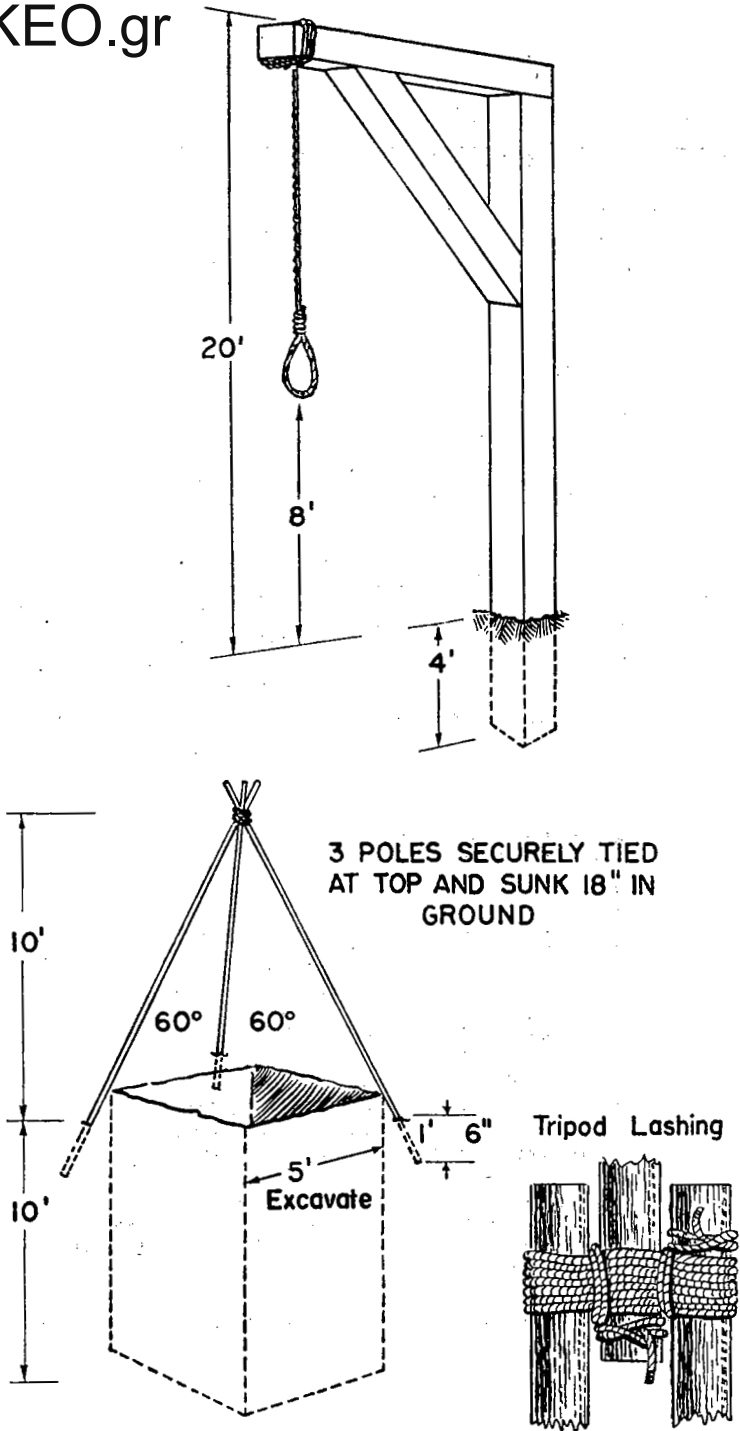
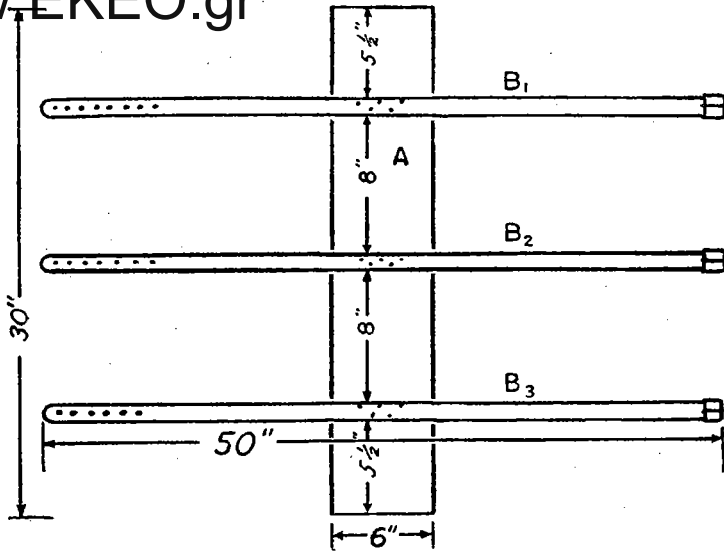

Figure 4. Emergency gallows, post type and tripod type.



A - Brace Board

B<sub>1</sub> B<sub>2</sub> B<sub>3</sub> = 1 inch straps

Figure 5. Collapse board.

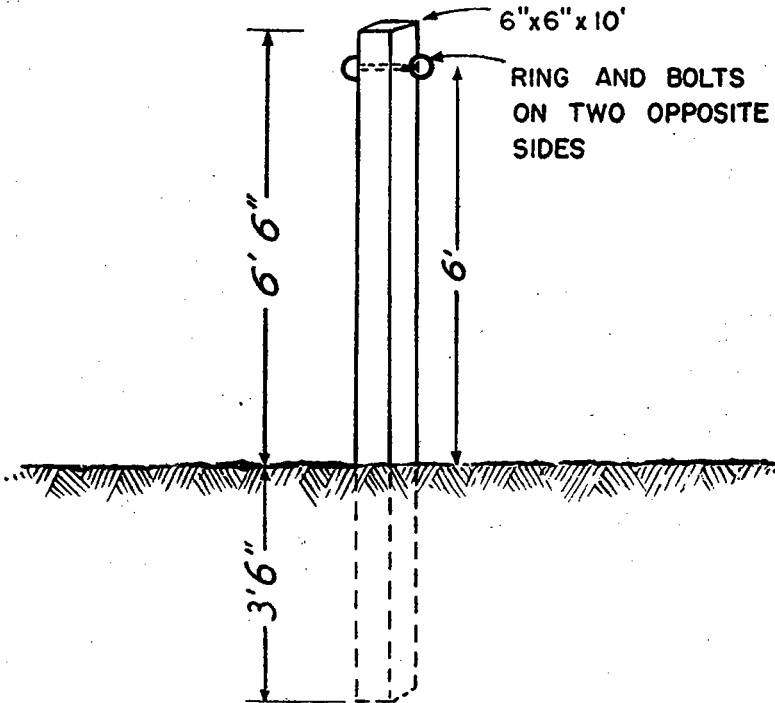
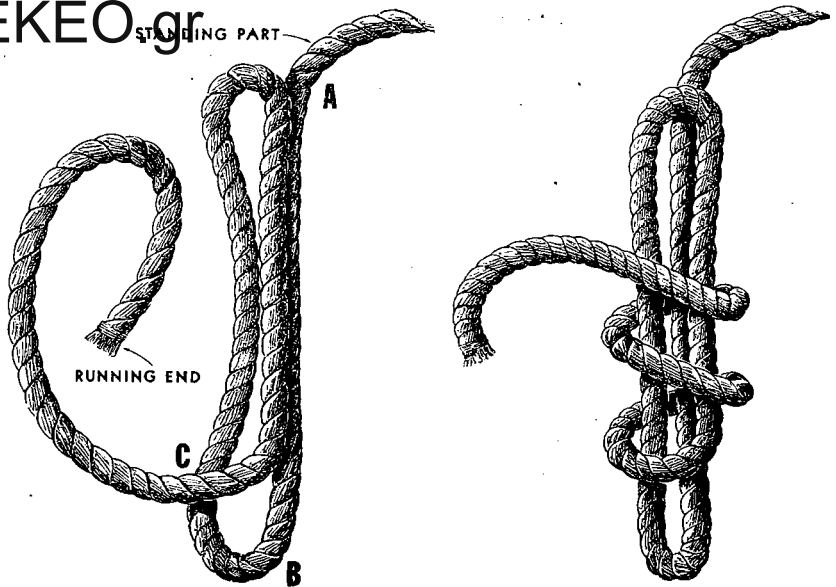
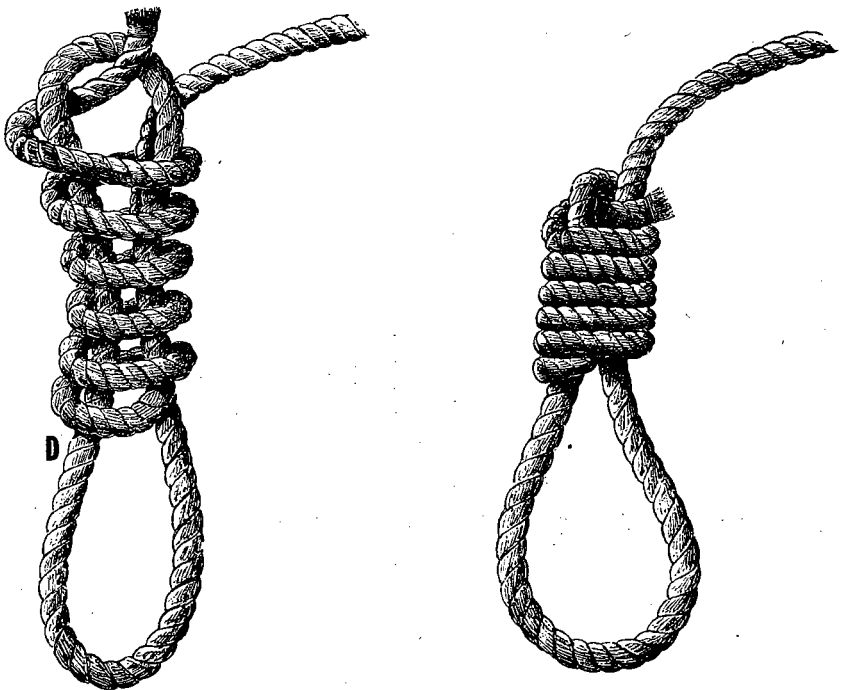

Figure 6. Post used in execution by musketry.



Length of loops: from A to B should be approximately 18 inches, and from C to Running End should be approximately 35 inches to 108 inches depending upon diameter of the rope. Wrap Running End around for six turns. No extra rope should remain.

Figure 7 ① and ②. Hangman's knot.



Tighten loops by pulling at Running End. Lock loops and form knot by pulling down at point D. Slide knot up or down on Standing Part to adjust size of loop.

Figure 7 ③ and ④.